

Towing bars and couplings

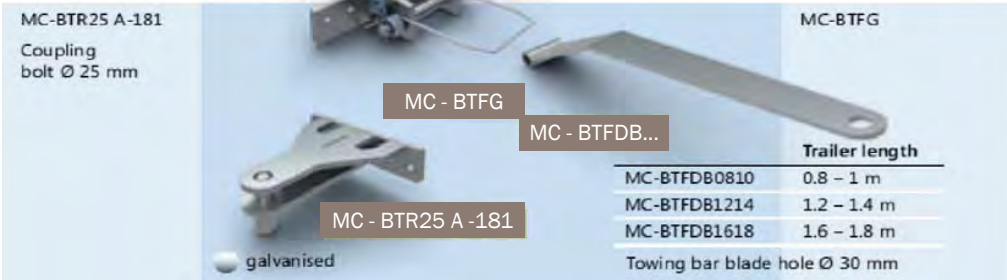

ACCESSORIES

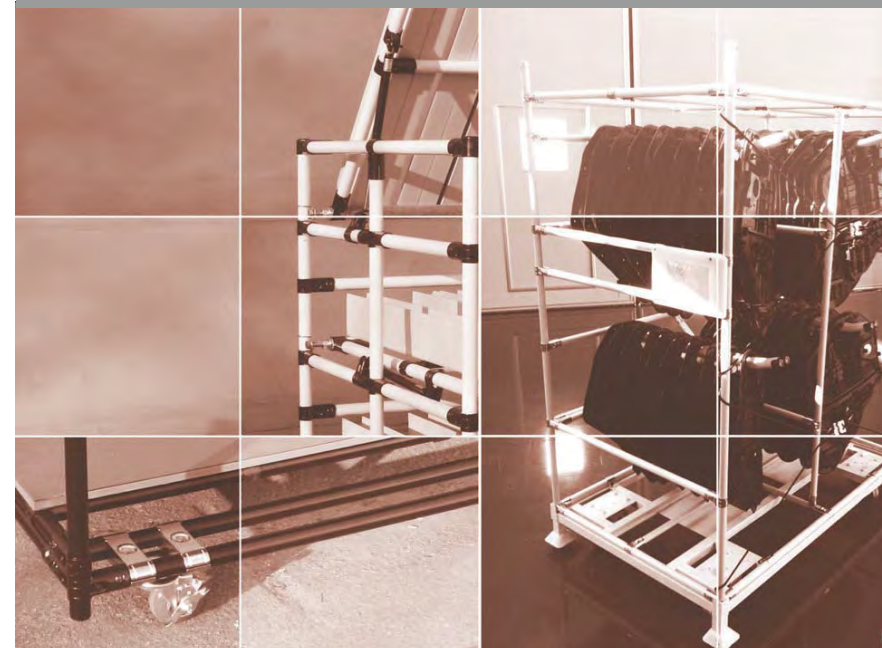

PLASTIC COLORS

- Ivoire
- Gray
- Green
- Black (ESD)
- Dark gray

MENU

Plastic accessories

Accessories	76
Separators / Clamps	77

Aluminium accessories

78 - 84

Tiles holder

Metal holder	85
Plastic & Struts	86

Identification

87 - 88

Caps

pipe caps	89 - 91
safety caps	91
roller track caps	92

Inserts

93 - 94

Legs

95 - 96

Screws

97

Security

98

Others

99 - 107

Unit : mm

L-Type

Part No		Thickness	H	W	Configuration
Normal	ESD				
AL-1	EAL-1	3	30	50	
AL-2	EAL-2	4	30	60	
AL-9	EAL-9	4	30	75	
AL-5B	EAL-5B	4	50	50	
AL-6B	EAL-6B	4	50	75	
AL-8	EAL-8	4	50	100	
AL-7B	EAL-7B	4	50	150	
AL-4	EAL-4	4	80	90	
AL-5	EAL-5	5	50	50	
AL-6	EAL-6	5	50	75	
AL-7	EAL-7	5	50	150	

T-Type

Part No		Thickness	H	W	Configuration
Normal	ESD				
AT-1	EAT-1	4	50	100	
AT-2	EAT-2	4	100	60	
AT-3	EAT-3	4	150	60	

U-Type

Part No		Thickness	W1	W2	H1	H2	Configuration
Normal	ESD						
AU-1	EAU-1	3	36	-	36	36	
AU-2	EAU-2	3	60	-	30	40	

S-Type

Part No		Thickness	W1	W2	H1	H2	Configuration
Normal	ESD						
AS-1	EAS-1	4	32	70	34	25	
AS-2	EAS-2	5	22	60	30	30	
AS-3	EAS-3	4	17	50	30	30	

Pipe-Cover

Part No		Thickness	θ	-	-	-	Configuration
Normal	ESD						
PC-01	EPC-01	2.5	75°	-	-	-	
PC-02	EPC-02	2.5	135°	-	-	-	

SEPARATEUR

Unit : mm

GAP-19 Plastic Joint

- Weight : 0.009kg
- Q'ty/Box : 750pcs

GAP-34 Plastic Joint

- Weight : 0.014kg
- Q'ty/Box : 500pcs

GAP-39 Plastic Joint

- Weight : 0.047kg
- Q'ty/Box : 160pcs

GAP-54 Plastic Joint

- Weight : 0.025kg
- Q'ty/Box : 150pcs

GAP-61 Plastic Joint

- Weight : 0.015kg
- Q'ty/Box : 500pcs

COLLIER



GAP-23 Plastic Joint

Include Bolt & Nut

- Weight : 0.020kg
- Q'ty/Box : 1500pcs

GAP-37A Plastic Joint

Sold separately Bolt & Nut

- Weight : 0.011kg
- Q'ty/Box : 600pcs

GAP-37B Plastic Joint

Sold separately Bolt & Nut

- Weight : 0.019kg
- Q'ty/Box : 300pcs

Unit : mm

ABS-620 Board Support



- Weight : 0.020kg
- Q'ty/Box : 300pcs

• ABS-600SA Standard Length: 4M

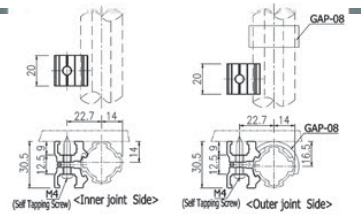

•Application Example: Reference page 89

ABS-4320A Board Support



- Weight : 0.020kg
- Q'ty/Box : 250EA

• ABS-4320A : 1pcs, APC-01 : 1pcs
• M0540 : 1pcs

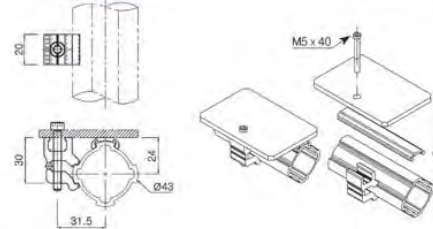

ACH-6040A AL Component Holder



- Weight : 0.017kg
- Q'ty/Box : 400EA

• Weight : 0.033kg
- Q'ty/Box : 150EA

• ACH-6040A-R : 1pcs, ACH-6040A-L : 1pcs
• M0612 : 1pcs, SN406 : 1pcs

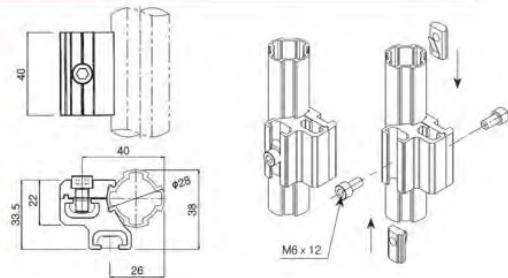

ACM-500 AL Caster Mount



- Weight : 0.054kg
- Q'ty/Box : 100pcs

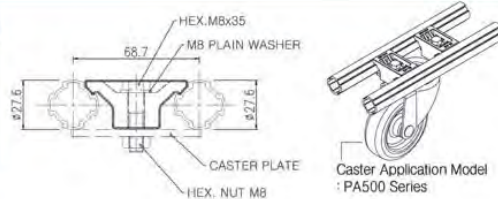

Caster Application Model
• PA500 Series

Unit : mm

ACP-H6026A Aluminum Connector Piece

ACP-H6026A-L



ACP-H6026A-R



- Weight : 0.007kg
- Q'ty/Box : 800EA

• ACP-H6026A-R : 1pcs, ACP-H6026A-L : 1pcs
• M0625 : 2pcs

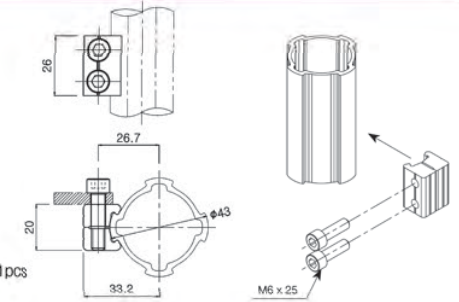

ACP-V6026A Aluminum Connector Piece

ACP-V6026A-L



ACP-V6026A-R



- Weight : 0.007kg
- Q'ty/Box : 800EA

• ACP-V6026A-R : 1pcs, ACP-V6026A-L : 1pcs
• M0620 : 1pcs, M0610 : 1pcs

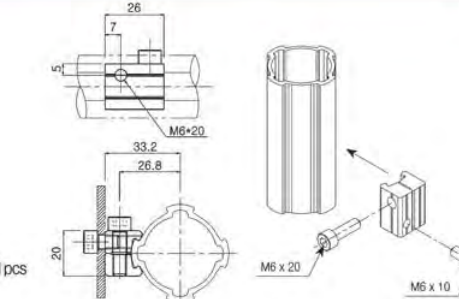

Unit : mm

Unit : mm

ADR-05-SA Door Rail



- Weight : 0.166kg/m
- Q'ty/Bundle : 20ea
- Standard Length: 4MT

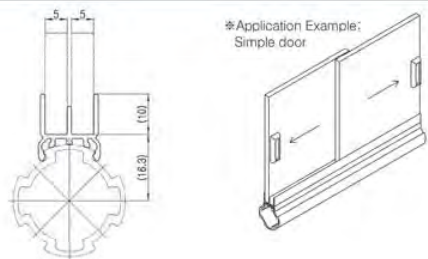

ADT-500 Slot Adapter



- Weight : 0.004kg
- Q'ty/Box : 1000pcs

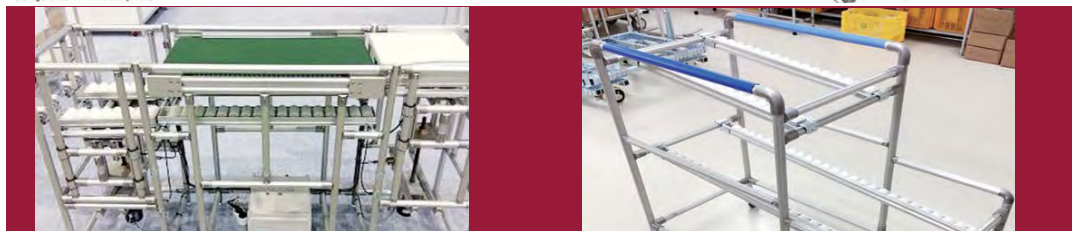
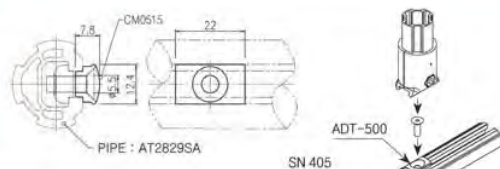

ADT-5043A Slot Adapter



- Weight : 0.014kg
- Q'ty/Box : 600EA
- ADT-5043A : 1pcs
- CM0520 : 1pcs, SN405 : 1pcs

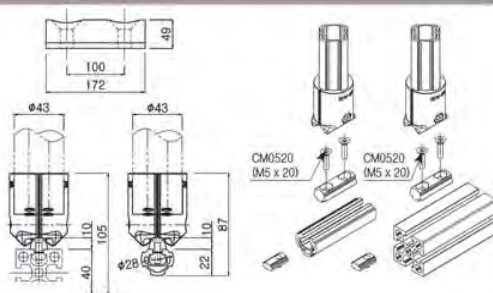

ANP-01-150 AL Name Plate



- Weight : 0.075kg
- Q'ty/Box : 150pcs
- Standard Length: 4MT : ANP-01SA

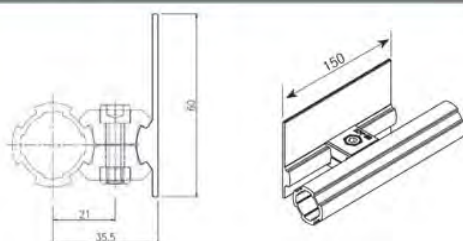

APC-01 Pipe Cover

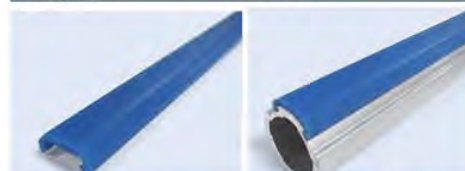

- Weight : 0.050kg
- Q'ty/Bundle : 50ea
- Standard Length: 3MT

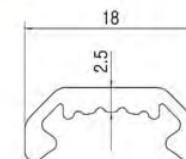

APC-03 Pipe Cover

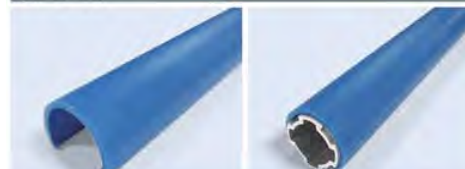

- Weight : 0.151kg
- Q'ty/Bundle : 20ea
- Standard Length: 3MT

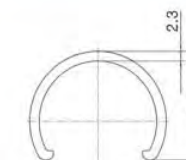

APH-633L, APH-633R Round Pipe Connect Joint



- Weight : 0.021kg/0.018kg
- Q'ty/Box : 200pcs
- APH-633L
- APH-633R

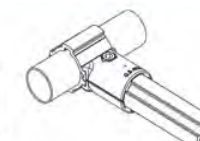
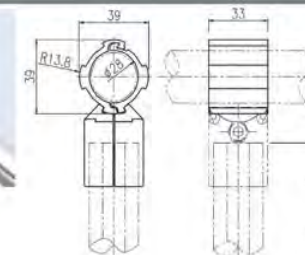

*Round Pipe (included Coated Pipe & Stainless Pipe)
Adaptor Joint between Round Pipe and Standard Aluminum Pipe (Profiled)

APH-3030A Round Pipe Connected Joint



- Weight : 0.031kg
- Q'ty/Box : 200EA
- APH-3030A-R : 1pcs, APH-3030A-L : 1pcs
- M0625 : 1pcs, PW06 : 1pcs

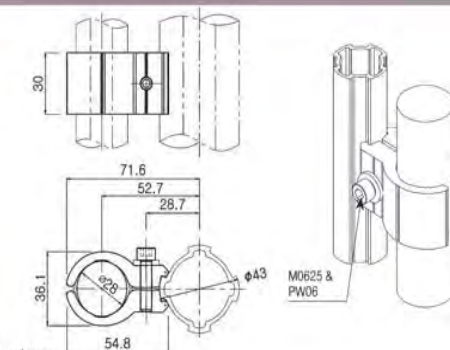

Unit : mm

LP2800 ELF Plate

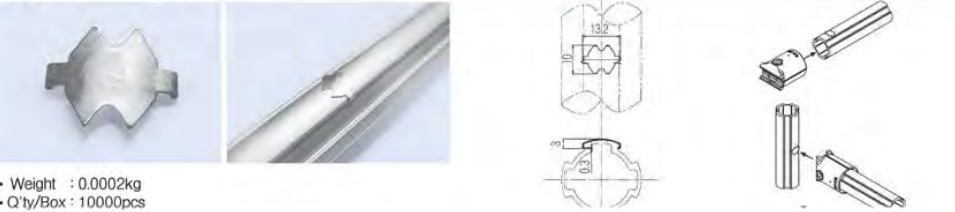

• Weight : 0.0002kg
• Q'ty/Box : 10000pcs

SN403/404/405/406/408 Spring Nut

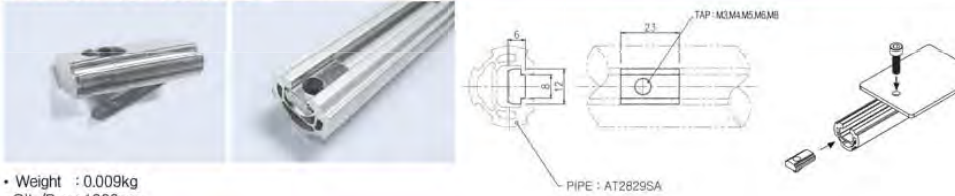

• Weight : 0.009kg
• Q'ty/Box : 1000pcs

BA-206 Crossover Joint (Angle Adjustable)



• B-206A: 1pcs, B-206B: 1pcs, B-206C: 1pcs, B-206D: 1pcs
• M0620/N06-55: 2set, M0625: 1pcs
• Weight : 0.117kg
• Q'ty/Box : 60set



• Weight : 0.020kg
• Q'ty/Box : 300pcs

• Weight : 0.020kg
• Q'ty/Box : 300pcs

• Weight : 0.035kg
• Q'ty/Box : 200pcs

• Weight : 0.020kg
• Q'ty/Box : 300pcs

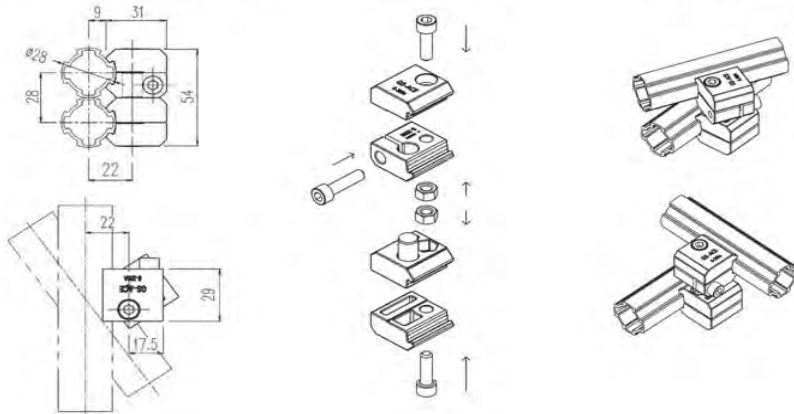

METAL HOLDER

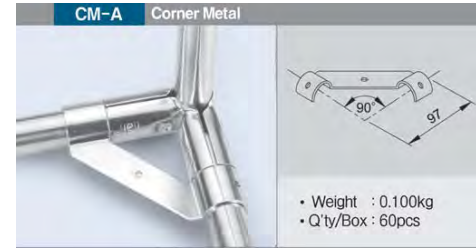

• Weight : 0.100kg
• Q'ty/Box : 60pcs

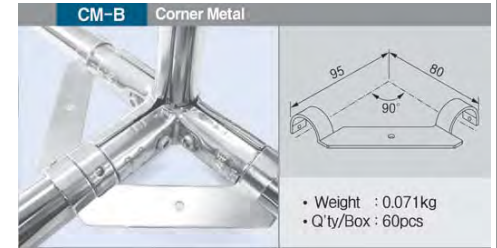

• Weight : 0.071kg
• Q'ty/Box : 60pcs

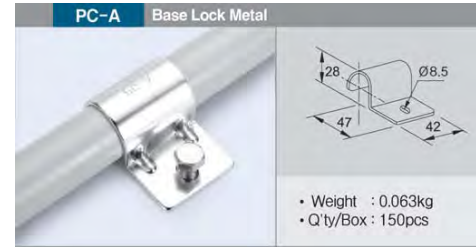

• Weight : 0.063kg
• Q'ty/Box : 150pcs



• Weight : 0.020kg
• Q'ty/Box : 300pcs



• Weight : 0.026kg
• Q'ty/Box : 200pcs

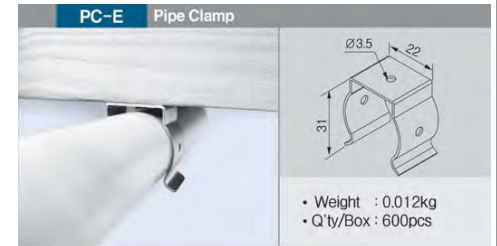

• Weight : 0.012kg
• Q'ty/Box : 600pcs



Unit : mm

PLASTIC HOLDER

GAP-7 Plastic Joint

- Weight : 0.011kg
- Q'ty/Box : 450pcs

GAP-8FN Horizontal Holder

- Weight : 0.005kg
- Q'ty/Box : 1200pcs

GAP-6 Label Holder

- Weight : 0.005kg
- Q'ty/Box : 1200pcs

GAP-6B Label Holder

- Weight : 0.005kg
- Q'ty/Box : 1200pcs

GAP-15 Sheet Holder

- Weight : 0.003kg
- Q'ty/Box : 1500pcs

GAP-17 Plastic Joint

- Weight : 0.014kg
- Q'ty/Box : 400pcs

GAP-20 Name Plate Holder

- Weight : 0.006kg
- Q'ty/Box : 1200pcs

GAP-55 Name Plate Holder (Assembled NP-B)

• firmly secured by M4 screw and nut.

Sold separately Bolt & Nut

- Weight : 0.009kg
- Q'ty/Box : 750pcs

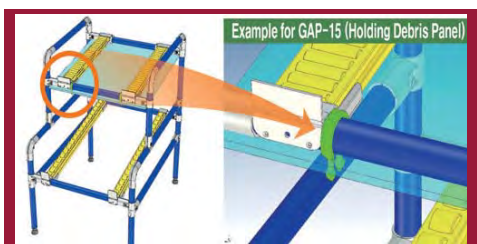

GAP-46 Plastic Joint

- Weight : 0.013kg
- Q'ty/Box : 450pcs

GAP-65 Corner Support Cap

Patent Pending

- Weight : 0.015kg
- Q'ty/Box : 400pcs

LA Label Case

- Weight : 0.044kg
- Q'ty/Box : 300pcs



LA-A3 Label Case

- Weight : 0.170kg
- Q'ty/Box : 200pcs

LA-C Label Case

- Weight : 0.050kg
- Q'ty/Box : 200pcs

STRUT

GAP-11 Taper Edge

- Weight : 0.002kg
- Q'ty/Box : 2500pcs

GAP-8 Horizontal Holder

- Weight : 0.005kg
- Q'ty/Box : 1200pcs



Unit : mm

Unit : mm

LA-D Label Case

- Weight : 0.012kg
- Q'ty/Box : 300pcs

LA-E Label Case

- Weight : 0.027kg
- Q'ty/Box : 300pcs

GAP-3 Outer Cap

- Weight : 0.009kg
- Q'ty/Box : 900pcs

GAP-4P Inner Cap

- Weight : 0.003kg
- Q'ty/Box : 1500pcs

LC Label Case

- Weight : 0.027kg
- Q'ty/Box : 300pcs

NP-A Name Plate

- Weight : 0.079kg
- Q'ty/Box : 180pcs

GAP-4R Rubber Cap

- Weight : 0.009kg
- Q'ty/Box : 900pcs



NP-B Name Plate

- Weight : 0.047kg
- Q'ty/Box : 360pcs

Utility Model Pending

NP-C Name Plate

- Weight : 0.035kg
- Q'ty/Box : 190pcs

GAP-4A Inner Cap

Part No.	Colors	Marking	Material
GAP-4A-G	Gray		Plastic
GAP-4A-B	Black	GAP-4A	
GAP-4A-i	Ivory		

- Weight : 0.003kg
- Q'ty/Box : 1500pcs

NP-D Name Plate

- Weight : 0.032kg
- Q'ty/Box : 190pcs

NP-E Name Plate

- Weight : 0.023kg
- Q'ty/Box : 450pcs

GAP-4AT T Slot Inner Cap

Part No.	Colors	Marking	Material
GAP-4AT-G	Gray		Plastic
GAP-4AT-B	Black	GAP-4AT	
GAP-4AT-i	Ivory		

- Weight : 0.002kg
- Q'ty/Box : 1500pcs

NP-F Name Plate (Requires GAP-58, sold separately)

- Weight : 0.017kg
- Q'ty/Box : 1,000pcs

NP-R Name Plate

- Weight : 0.011kg
- Q'ty/Box : 1,000pcs

GAP-43A Inner Cap

- Weight : 0.005kg
- Q'ty/Box : 900EA

Unit : mm

GAP-9C Grip Bushing(Coating Pipe:Ø28×T1.0)

- Weight : 0.016kg
- Q'ty/Box : 450pcs

GAP-9S Grip Bushing(STS Pipe:Ø28×T0.7)

- Weight : 0.016kg
- Q'ty/Box : 450pcs

RF-01 Rubber Foot

RF-01 : Normal (D/Gray)
RF-01E : ESD (Black)

- Weight : 0.035kg
- Q'ty/Box : 250pcs

RF-02 Rubber Foot

- Weight : 0.011kg
- Q'ty/Box : 450pcs

GAP-52A Roller Conveyor Cap (With Bearing)

- Weight : 0.013kg
- Q'ty/Box : 1500pcs

GAP-50 Roller Conveyor Cap (Without Bearing)

- Weight : 0.008kg
- Q'ty/Box : 1200pcs

GAM-07S	METAL CAP	Part No	Pipe	Diameter	Remark
		GAM-07S	STS Pipe	Ø28 X t0.7	WZ
	<ul style="list-style-type: none"> • Weight : 0.037kg • Q'ty/Box : 500pcs 				

GAS-07S	STEEL CAP	Part No	Pipe	Diameter	Remark
		GAS-07A	Coated Pipe	Ø28x t 0.7	WZ
		GAS-10A		Ø28 x t 1.0	WZ
		GAS-07S	STS/Eco Pipe	Ø28 x t 0.7	WZ
		GAS-12S		Ø28 x t 1.2	WZ
	<ul style="list-style-type: none"> • Weight : 0.009kg • Q'ty/BOX : 600pcs 				

Unit : mm

INNER CAP

Classification	Part No	Colors	Marking	Material	Dimension			
Ø28	All Thickness Pipe (Coated Pipe & STS Pipe)	GAP-4P-I	Ivory	GAP-4P				
		GAP-4P-B	Black					
		GAP-4P-G	Gray					
	Coated Pipe	GAP-4R-B	Black	GAP-4R				
			GAP-4C-I			Ivory	GAP-4C	
			GAP-4C-B			Black		
GAP-4C-G	Gray							
STS Pipe ECO Pipe	GAP-4S-I	Ivory	GAP-4S					
		GAP-4S-B			Black			
		GAP-4S-G			Gray			
Ø32	Coated Pipe	GAP-4310-I	Ivory	GAP-4310				
		GAP-4310-B	Black					
		GAP-4310-G	Gray					

SAFETY CAP

ASC-V30 Vertical Safety Cap

- Weight : 0.001kg
- Q'ty/Box : 6000pcs

ASC-H42R Horizontal Safety Cap

- Weight : 0.001kg
- Q'ty/Box : 4000pcs

ASC-H42L Horizontal Safety Cap

- Weight : 0.002kg
- Q'ty/Box : 4000pcs

ASC-V45 Vertical Safety Cap

- Weight : 0.002kg
- Q'ty/Box : 4000pcs

Unit : mm

Unit : mm

PRC-25A Recycle Roller Cap



- Weight : 0.002kg
- Q'ty/Box : 1500pcs

PRC-35 Roller Track Cap





- Weight : 0.004kg
- Q'ty/Box : 1000pcs

PRC-40 Roller Track Cap



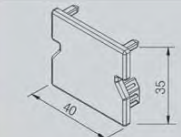

- Weight : 0.005kg
- Q'ty/Box : 1000pcs

PRC-40A Recycle Roller Cap





- Weight : 0.005kg
- Q'ty/Box : 1000pcs

PRC-60 Roller Track Cap

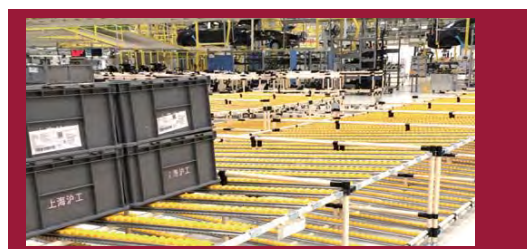

- Weight : 0.006kg
- Q'ty/Box : 600pcs



PRC-60B Recycle Roller Cap





- Weight : 0.007kg
- Q'ty/Box : 600pcs

PRC-60A Recycle Roller Cap





- Weight : 0.009kg
- Q'ty/Box : 600pcs

PRC-85A Recycle Roller Cap





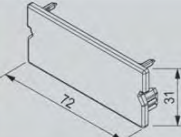







- Weight : 0.010kg
- Q'ty/Box : 400pcs

PRC-70A Recycle Roller Cap

- Weight : 0.008kg
- Q'ty/Box : 600pcs

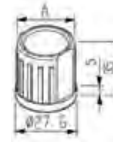
THREAD INSERTS

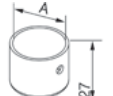
	Part No	Classification	Application	Colors	Threaded Spex	Matériel	A	Dimension			
	BC2807D	Coated Pipe	Ø28 x t0.7	White	M10-P1.5	Steel	Ø24.1				
	BC2810A		Ø28 x t1.0	White	1/2" - P1.5	Steel	Ø23.5				
	BC2810B			M12 - P1.75							
	BC2810D			M10 - P1.5							
	BC2820A		Ø28 x t2.0	White	1/2" - 12N	Steel	Ø21.9				
	BC2820B			M12 - P1.75							
	BC2820D			M10 - P1.5							
			BS07A	STS Pipe	Ø28 x t0.7	White	1/2" - 12N		Steel	Ø26.8	
			BS07B				M12 - P1.75				
			BS07D				M10 - P1.5			Ø26.3	
BS12A		Ø28 x t1.2	White		1/2" - 12N	Steel	Ø25.5				
BS12B			M12 - P1.75								
BS12D			M10 - P1.5		Ø25.3						
	BC3210A	Coated Pipe	Ø32 x t1.0	White	1/2" - 12N	Steel	Ø27.5				
	BC3210B				M12 - P1.75						
	AS2807A	STS Pipe	Ø28 x t0.7	Gray	M12 - P1.75	Aluminium	Ø26.5				
	AS2801B				1/2" - 12N						
	AC2809A	Coated Pipe	Ø28 x t1.0		M12 - P1.75		Ø23.8				
	AC2809B				1/2" - 12N						
	OB28AN	All Pipe	Ø28	White	1/2" - 12N	Steel	Ø27.7				
	OB28BN				M12 - P1.75						

Unit : mm

BA2800A/B AL Thread Insert

Part No.	"A" Tap	Remark
BA2800A	1/2"-12N	
BA2800B	M12-p1.75	

- Weight : 0.017kg
- Q'ty/Box : 300pcs

BP2800A/B AL Plastic Thread Insert

Part No.	"A" Tap	Colors	Marking	Material
BP2800A	1/2"-12N	Ivory	BP2800A	Plastic+
BP2800B	M12-p1.75	Gray	BP2800B	SUS304

- Weight : 0.011kg
- Q'ty/Box : 800pcs

BP2800H AL Plastic Thread Insert

Part No.	Colors	Remark	"A" Tap	Part No.	Remark
BP2800	Gray		M12	N12-S12(SUS 304)	Special
			1/2"-12N	N1/2"-S12(SUS 304)	

- Weight : 0.011kg
- Q'ty/Box : 800pcs
- Housing : 2pcs
- Nut : 1pcs

BP4300H AL Plastic Thread Insert

- Weight : 0.014kg
- Q'ty/Box : 800EA
- BP4300H : 2pcs, Sts Nut : 1pcs

Unit : mm

SMALL TYPE

AD30PA LEVELING FOOT

- Weight : 0.035kg
- Q'ty/Box : 150pcs

AD32WA LEVELING FOOT

- Weight : 0.053kg
- Q'ty/Box : 125pcs

NORMAL TYPE

	Part No	Base Diameter	Threaded Spec	Threaded Length	ESD	Type
	AD32WB	Ø32	1/2"-12N	50	○	
	AD32WC			100	○	

	AD50WA/B	AD50WA/B-AC	Part No	Base Diameter	Threaded Spec	Threaded Length	ESD	Type
			AD50WA	Ø50	1/2"-12N	50	○	
			AD50WB			100	○	
			AD50WA-AC	Ø50	1/2"-12N	50	○	
			AD50WB-AC			100	○	

STS TYPE

	Part No	Base Diameter	Threaded Spec	Threaded Length	ESD	Type
	AD35SA	Ø35	1/2"-12N	50	○	
	AD35SB			100	○	
	AD40SPA	Ø40	1/2" -12N (Rubber Type)	50	○	
	AD40SPB			100	○	

RUBBER PAD-TYPE

	Part No	Base Diameter	Threaded Spec	Threaded Length	ESD	Type
	AD50RAN	Ø50	1/2"-12N	50	×	
	AD50RAN-E			50	○	
	AD50RBN			100	×	
	AD50RBN-E			100	○	

	Part No	Base Diameter	Threaded Spec	Threaded Length	ESD	Type
	AD32RA	Ø32	1/2"-12N	50	×	
	AD32RA-E			50	○	
	AD32RB			100	×	
	AD32RB-E			100	○	

Unit : mm

AD-SM Stanchion Mount Single

• Weight : 0.198kg
• Q'ty/Box : 20pcs

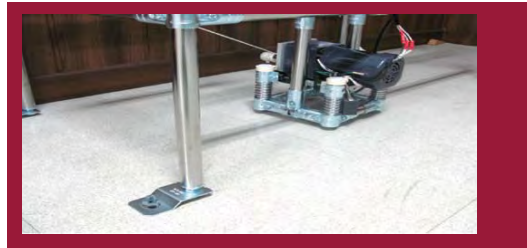

AP-50 Anchor Plate

• Weight : 0.052kg
• Q'ty/Box : 220pcs

HC28A Hole Cup-A

• Weight : 0.300kg
• Q'ty/Box : 20pcs

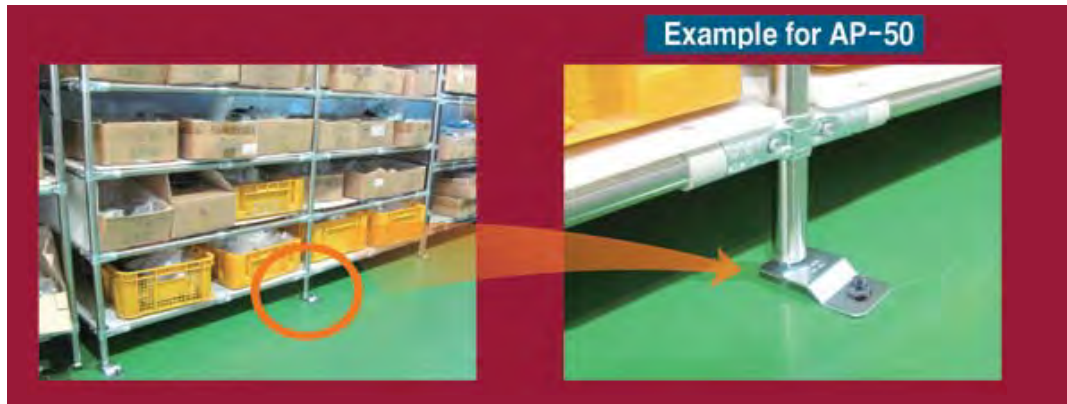

AD-SM43A Stanchion Mount Single

• Weight : 0.680kg
• Q'ty/Box : 50EA

• AD-SM43A : 1pcs.
• HM0615 : 1pcs

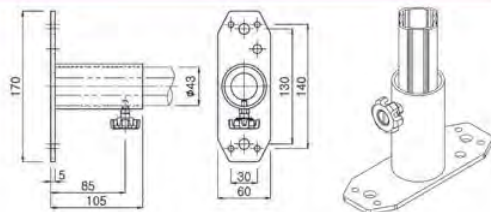

Fastener Type	Part No	Item	Spec	Colors	Usage
	TN06W	T-Nut	M6	White	Metal Joint
	TN06B		M6	Black	
	SW10W	Spring Washer	M10	White	M10Bolt
	SW13W		M12		M12Bolt
	PW05W	Flat Washer	M5	White	M5Bolt
	PW10W		M10		M10Bolt

Fastener Type	Part No	Item	Spec	Colors	Usage		
	M0610W	M6x10	P 1.0	White	Metal Joint		
	M0610B			Black			
	M0625W	M6x25	P 1.0	White	Metal Joint		
	M0625B			Black			
	M0630W	M6x30	P 1.0	White			
	M0630B			Black			
	M0830W	M8x30	P1.25	White	AL Joint		
	M0840W					M8x40	P1.25
	M1020W	M10Bolt	L20	White	Caster		
	M1225W					M12Bolt	L25
	GM835W					M8Bolt	L35xP1.25
GM840W	M8Bolt	L40xP1.25					
GM845W		L45xP1.25					
GM850W	L50xP1.25	Base Lock Metal					
GM860W	L60xP1.25						
GM870W	L70xP1.25						
	HM0620	KNOB Bolt	P1.0	Black	Metal Joint		

	NN06W	Nylon Nut	M6	White	M6Bolt
	NN08W		M8		M8Bolt
	NN10W		M10		M10Bolt
	NN12W		M12		M12Bolt

	N06W	Nut	M6	White	M6 Bolt
	N08W		M8		M8 Bolt
	Ni05W-12		inch Nut		1/2"-12N

Other screws : contact AT Sourcing

Unit : mm

RS - 2B Safety Reflector

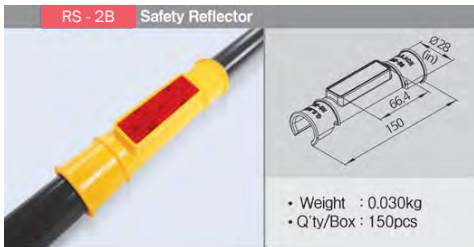

• Weight : 0.030kg
• Q'ty/Box : 150pcs

CD - 28C/D Cable Duct

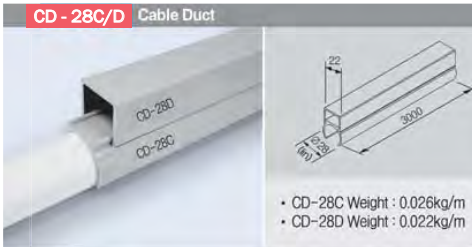

• CD-28C Weight : 0.026kg/m
• CD-28D Weight : 0.022kg/m

MJC - G1

Matériel : PP
Unit : EA

MJC - G1 ASS'Y

Weight : 12,5 g
Size (mm) : 465 x 260 x 260 (H)
Q'ty / Box : 150 EA
Gross weight : 2 kg
MJC - G1 ASS'Y Requires MJC-G1 2 EA

MJC - G2

Matériel : PP
Unit : EA

MJC - G4 ASS'Y

Weight : 12,4 g
Size (mm) : 465 x 260 x 260 (H)
Q'ty / Box : 100 EA
Gross weight : 1,6 kg
MJC - G2 ASS'Y Requires MJC-G2 4 EA

MJC - G3

Matériel : PP
Unit : EA

MJC - G3 ASS'Y

Weight : 20,1 g
Size (mm) : 465 x 260 x 260 (H)
Q'ty / Box : 100 EA
Gross weight : 2,5kg
MJC - G3 ASS'Y Requires MJC-G2 + MJC-G1

MJC - G4

Matériel : PP
Unit : EA

MJC - G4 ASS'Y

Weight : 19 g
Size (mm) : 465 x 260 x 260 (H)
Q'ty / Box : 100 EA
Gross weight : 2,4kg
MJC - G4 ASS'Y Requires MJC-G4 2 EA

CONVOYER

GAP-48 Roller Conveyor Holder (Single)



• Weight : 0.013kg
• Q'ty/Box : 500pcs

GAP-49 Roller Conveyor Holder (Double)

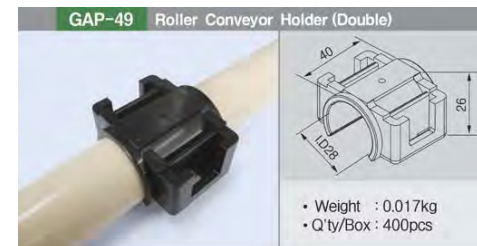

• Weight : 0.017kg
• Q'ty/Box : 400pcs

GAP-51 Roller Conveyor Support

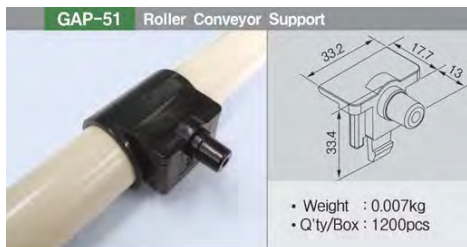

• Weight : 0.007kg
• Q'ty/Box : 1200pcs

ACCESSORIES

GAP-41 Plastic Joint

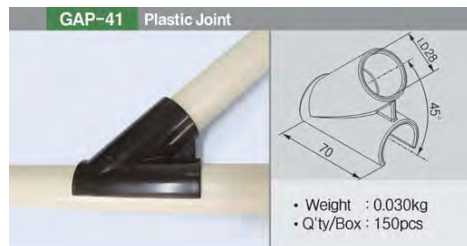

• Weight : 0.030kg
• Q'ty/Box : 150pcs



GAP-42 Plastic Joint

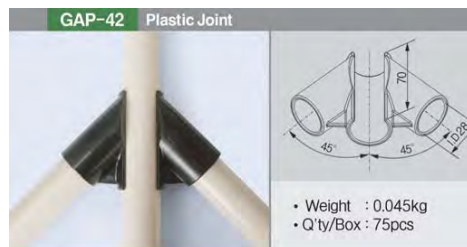

• Weight : 0.045kg
• Q'ty/Box : 75pcs



GAP-43 Plastic Joint

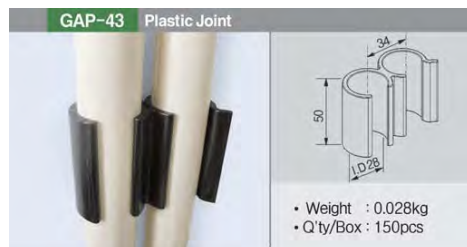

• Weight : 0.028kg
• Q'ty/Box : 150pcs

Unit : mm

Unit : mm

BC45-A Base Corner

- Weight : 1.85kg
- Q'ty/Box : 8pcs

BC45-B Base Center

- Weight : 1.17kg
- Q'ty/Box : 4pcs

BS-01 Box-Stopper (Requires CM-200 : sold separately)

- Weight : 1.78kg
- Q'ty/Box : 8pcs

BS-15 Back Stopper Bracket

- Weight : 0.105kg
- Q'ty/Box : 60pcs



BC45-C Base Center

- Weight : 1.28kg
- Q'ty/Box : 4pcs

BUSH-12 Sleeve Busing(Metal)

- Weight : 0.035kg
- Q'ty/Box : 180pcs

CB-MCP Corner Bumper

- Weight : 0.034kg
- Q'ty/Box : 150pcs

BH-B Band Hook

- Weight : 0.001kg
- Q'ty/Box : 2,000pcs

CP-32 Cover Pulley

- Weight : 0.004kg
- Q'ty/Box : 3000pcs

CS28L Corner Support

- Weight : 0.682kg
- Q'ty/Box : 24pcs

BH-A Band Hook

- Weight : 0.001kg
- Q'ty/Box : 1,000pcs

BL28YA-U Pipe Holder

- Weight : 0.069kg
- Q'ty/Box : 150pcs

CS28R Corner Support

- Weight : 0.750kg
- Q'ty/Box : 24pcs

DL-15 Door Latch

- Weight : 0.305kg
- Q'ty/Box : 40pcs

BRA-32 Bearing Pulley

- Weight : 0.012kg
- Q'ty/Box : 1,000pcs

BKT-40 Curve Roller Mounting

- Weight : 0.055kg
- Q'ty/Box : 200pcs

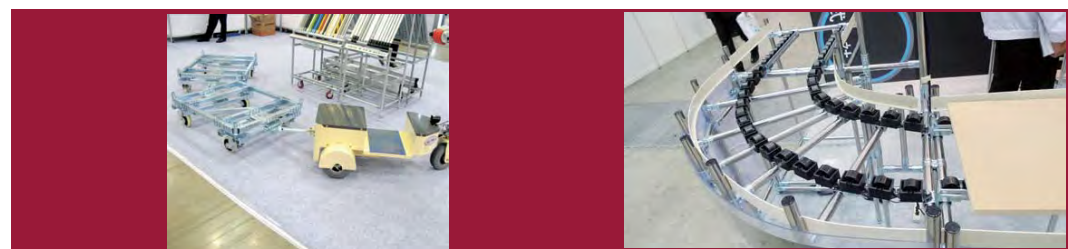

Unit : mm

Unit : mm

ECH-28A End Cap Hanger

- Weight : 0.056kg
- Q'ty/Box : 45pcs

F-A Handle(Flat Type)

- Weight : 0.020kg
- Q'ty/Box : 500pcs

GB-02 Gap Bushing

- Weight : 0.006kg
- Q'ty/Box : 2,000pcs



FH-A Front Haul Ring-A

- Q'ty/Box : 5pcs

GRH-15L Ass'y Bearing Pulley Ass'y Left

GRH-15L : 1pcs, G-15BS : 1pcs
BRA-32 : 1pcs, GB-02 : 1pcs
M0625 : 1pcs, M0610 : 1pcs

GRH-15L Pulley Holder BKT Left

- Weight : 0.055kg
- Q'ty/Box : 270pcs

FH-B Rear Haul Ring-B

- Q'ty/Box : 10pcs

GRH-15R Ass'y Bearing Pulley Ass'y Right

GRH-15R : 1pcs, G-15BS : 1pcs
BRA-32 : 1pcs, GB-02 : 1pcs
M0625 : 1pcs, M0610 : 1PCS

GRH-15R Pulley Holder BKT Right

- Weight : 0.055kg
- Q'ty/Box : 270pcs

FQ-B Front Haul Ass'y-Quicking Type

- Weight : 3.10kg
- Q'ty/Box : 4pcs

FS-A Front Haul Ass'y-Spring Type

- Weight : 3.40kg
- Q'ty/Box : 4pcs

GRV-15L Ass'y Bearing Pulley Ass'y Left

GRV-15L : 1pcs, G-15BS : 1pcs
BRA-32 : 1pcs, GB-02 : 1pcs
M0625 : 1pcs, M0610 : 1pcs

GRV-15L Pulley Holder BKT Left

- Weight : 0.055kg
- Q'ty/Box : 240pcs



GRV-15R Ass'y Bearing Pulley Ass'y Right

GRV-15R : 1pcs, G-15BS : 1pcs
BRA-32 : 1pcs, GB-02 : 1pcs
M0625 : 1pcs, M0610 : 1pcs

GRV-15R Pulley Holder BKT Right

- Weight : 0.055kg
- Q'ty/Box : 240pcs

Unit : mm

Unit : mm

GS-1014A Sleeve Hanger

- Weight : 0.130kg
- Q'ty/Box : 70pcs

GS-1014B Sleeve Hanger

- Weight : 0.124kg
- Q'ty/Box : 70pcs

HP-30L Holder Panel

- Weight : 0.030kg
- Q'ty/Box : 240pcs

HP-30R Holder Panel

- Weight : 0.022kg
- Q'ty/Box : 400pcs

GS-1014C Sleeve Hanger

- Weight : 0.050kg
- Q'ty/Box : 200pcs

GS-1250A End Snap Rest

- Weight : 0.100kg
- Q'ty/Box : 90pcs

LRA-19 Linear Roller

- Weight : 0.017kg
- Q'ty/Box : 300EA

PHR-28 Hang Roller

- Weight : 0.040kg
- Q'ty/Box : 100pcs

GS-2070C Pipe Plug

- Weight : 0.120kg
- Q'ty/Box : 100pcs

* Reference page 52

GS-2070D Slide Pipe Plug

- Weight : 0.200kg
- Q'ty/Box : 90pcs

MB-15 Monitor Bracket

- Weight : 0.350kg
- Q'ty/Box : 20pcs

PH-A Hanger

- Weight : 0.001kg
- Q'ty/Box : 500pcs

HG-D Hinge Metal

- Weight : 0.052kg
- Q'ty/Box : 100pcs

HK28WA Pipe Rest

- Weight : 0.094kg
- Q'ty/Box : 90pcs

PC-D Pipe Lock Metal

- Weight : 0.157kg
- Q'ty/Box : 50pcs

HK28WB Pipe Rest

- Weight : 0.124kg
- Q'ty/Box : 70pcs

HM28YA Hanger Metal

- Weight : 0.049kg
- Q'ty/Box : 100pcs

EXEMPLE MB - 15

Unit : mm

Unit : mm

QS-28 Quick Stopper

- Weight : 0.370kg
- Q'ty/Box : 18pcs

R-A Handle(Round Type)-L400

Design Patent No. 0296008

- Weight : 0.020kg
- Q'ty/Box : 400pcs

TH40PA Tool Holder-Plastic

- Weight : 0.080kg
- Q'ty/Box : 50pcs

TH50PA Tool Holder-Plastic

- Weight : 0.074kg
- Q'ty/Box : 50pcs

RB-2880A Ring Bumper

- Weight : 0.060kg
- Q'ty/Box : 150pcs

RB-3480A Ring Bumper

- Weight : 0.065kg
- Q'ty/Box : 150pcs

TH50YA Tool Holder

- Weight : 0.108kg
- Q'ty/Box : 25pcs

TH60PA Tool Holder-Plastic

- Weight : 0.067kg
- Q'ty/Box : 50pcs

RQ-B Rear Haul Ass'y-Quicking Type

- Weight : 2.10kg
- Q'ty/Box : 4pcs

RQ-C Rear Haul Ass'y-Quicking Type

- Weight : 3.38kg
- Q'ty/Box : 6pcs

TH60PB Tool Holder-Plastic

- Weight : 0.070kg
- Q'ty/Box : 50pcs

TH65YA Tool Holder

- Weight : 0.197kg
- Q'ty/Box : 25pcs

RS-A Rear Haul Ass'y-Spring Type

- Weight : 1.50kg
- Q'ty/Box : 4pcs

TC-28 Tool Cap

- Weight : 0.011kg
- Q'ty/Box : 600pcs

Example for TC-28

Example for Tool Holder





AT SOURCING

ZI Les Malines CE 2701
22 rue des Malines
91090 LISSES

Tél : +33 (0)1 60 86 88 22
Fax : +33 (0)1 60 86 18 22
E-mail : commercial@atsourcing.fr

www.atsourcing.fr

Février 2023