

Unit : mm

## 45X45 ALUMINIUM JOINTS & ACCESSORIES

### E-001

실용신안 출원



- Weight : 0.050kg
- Q'ty/Box : 100pcs

- E-001 : 2EA
- M0830/N08 : 1set
- Weight : 0.120kg
- Q'ty/Box : 50set

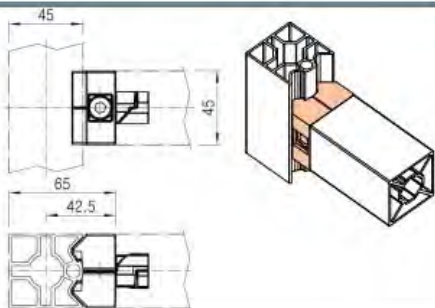

### B-080A



- Weight : 0.062kg
- Q'ty/Box : 40pcs

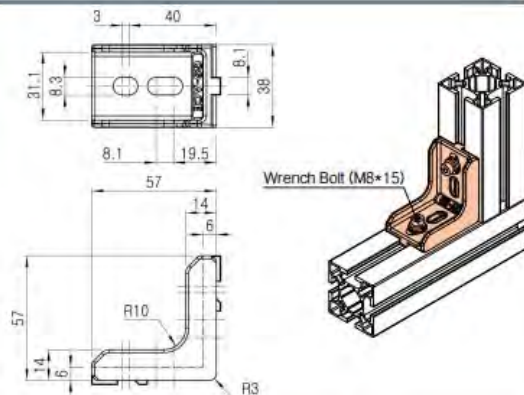

### BA4545A/B



- Weight : 0.034kg
- Q'ty/Box : 200pcs

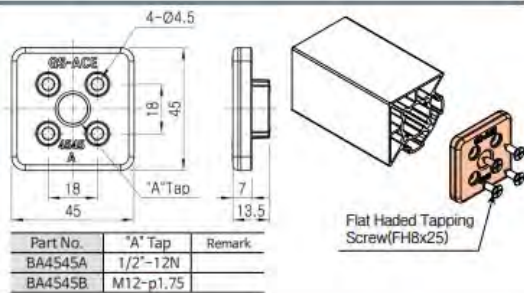

### GAP-4545D



- Weight : 0.006kg
- Q'ty/Box : 1200pcs

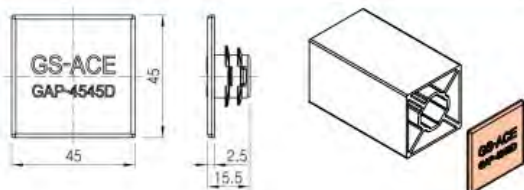

# ROLLER TRACKS



### SERIES

- GP - 25
- GP - 35
- GP - 40
- GP - 60
- GP - 70
- GP - 85

### ROLLER TRACK NUMBERING SYSTEM

- WH = white
- GR = Gray
- BK = Black
- YL = Yellow

Color Code

- A : Round
- B : Flat
- BF : Flexible
- C : Flange
- D : Large
- HA : Taper
- M : Multi
- S : Slim
- SR : STS Covered roller

Roller Type

### CHOOSE FOR THE ROLLER TYPE

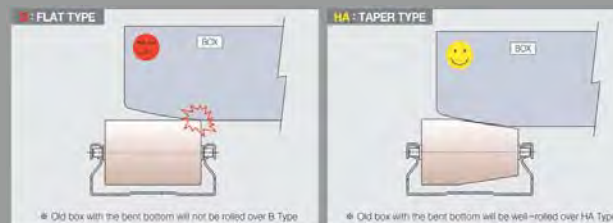

GP 40 36 A

Pitch

Serie / Frame Size

Unit : mm

### BENDING STRENGTH FOR PIPE

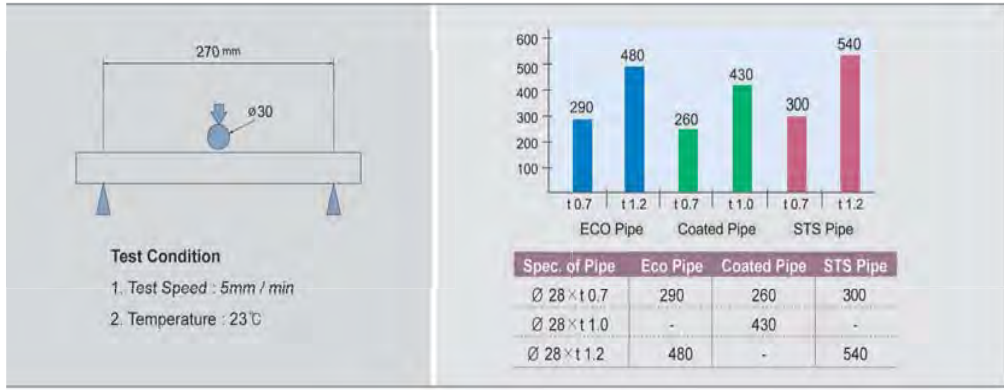

### BENDING STRENGTH FOR ROLLER TRACK

Unit : kgf

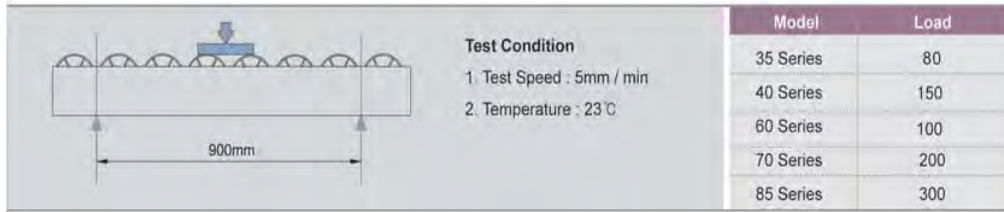

### BENDING STRENGTH OF WHEEL SUBASSEMBLY

Unit : kgf

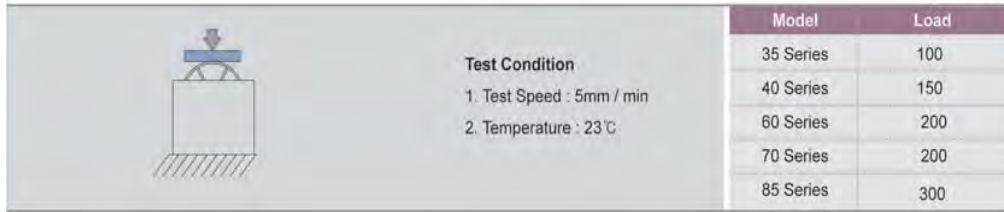

### BENDING STRENGTH FOR CONSISTENT



Unit : mm

Series	Part No.	Body Material (mm)	Load Capacity (Kg-f)	Roller Diameter (mm)	Shaft Diameter (mm)	Roller Pitch (mm)	Slope >(°)	Roller Color				ESD		Standard Length		
								WH	GR	BK	YL	BK	GR			
<b>Silent Roller Track</b>																
25 Series	GPR2528A	AL	60	∅25	∅3	28.57	1.5°	○	○						4MT	
40 Series	GPR4040A	AL (Aluminium)	150	∅34	∅4	40	2.0°	○	○	○	○				4MT	
	GPR4040B							○	○	○	○					
	GPR4055C							○	○	○	○					
60 Series	GPR6016S	AL	100	∅15	∅4	16.67	2.5°	○	○	○	○				4MT	
	GPR6033B		150	∅30	∅4	33.33		○	○	○	○					
	GPR6033HA		150	∅30	∅4	33.33		○	○	○	○					
70 Series	GPR7042B	AL	200	∅34	∅5	42	3.5°	○	○	○	○				4MT	
	GPR7042BF							○	○	○	○					
	GPR7021BFS-2							∅17.6	21	-				○		
85 Series	GPR8523S	AL	200	∅20.5	∅3.5	22.5	1.5°	○	○	○	○				4MT	
	GPR8545B							○	○	○	○					
	GPR8545HA		300	∅40		45		○	○	○	○					
	GPR8545SR							∅43	○	○	○	○				

### Standard Roller Track

35 Series	GP3533B	SPCC	100	∅28	∅3	33.33	2.5°	○	○	○	○								
40 Series	GP4036A	SPCC (Galvanized Steel Chrome Free)	150	∅34	∅4	36	2.0°	○	○	○	○				4MT				
	GP4036B							○	○	○	○								
	GP4040A							○	○	○	○								
	GP4040B							○	○	○	○								
	GP4050C							○	○	○	○								
	GP4050D							○	○	○	○								
60 Series	GP4025M	SPCC	100	∅34	∅3.3	25	2.5°	○	○	○	○								
	GP6016S							150	∅15	∅4	16.67	2.5°	○	○	○	○			4MT
	GP6033B												∅30	33.33	○	○	○	○	
70 Series	GP6033HA	SPCC	150	∅30	∅4	33.33	2.5°	○	○	○	○				4MT				
	GP7050BF							200	∅34	∅5	50	3.5°			○	○			4MT
85 Series	GP8525M	SPCC	300	∅34	∅5	25	2.5°	○	○	○	○				4MT				
	GP8543B							∅40	43	○	○	○	○						
	GP8550SR							∅43	∅3.5	50	1.5°	○						2MT	

### Curve Roller

40 Series	CR40A	SPCC (Galvanized Steel Chrome Free)	100	∅34	∅4	76	2.0°	○	○	○	○				-
	CR40B							○	○	○	○				
	CR40D							○	○	○	○				

### Universal Roller Track

40 Series	UR4050	AL	100	∅43	∅4	50	2.5°	○		○				3MT
60 Series	UR6067		200	∅60	∅5	66.7	3.0°	○		○				2MT

Unit : mm

Unit : mm

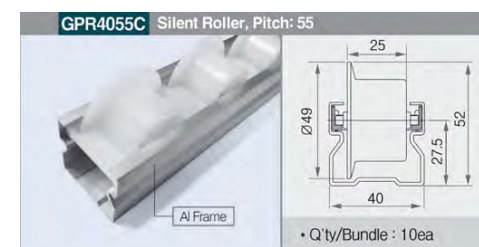
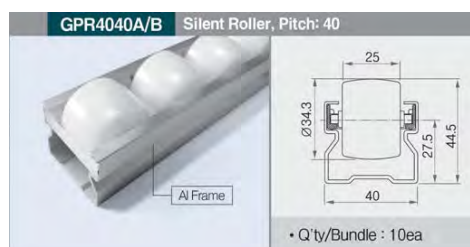
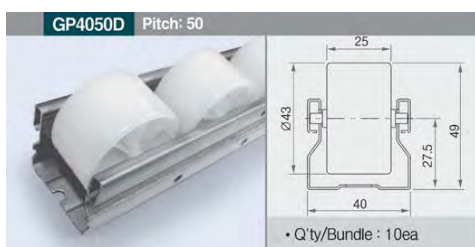
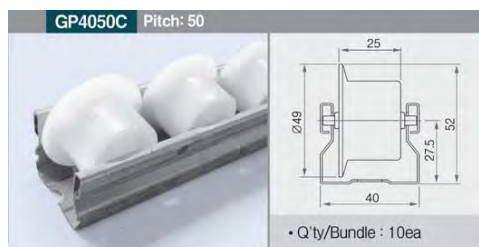
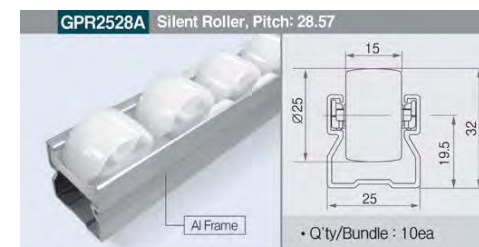
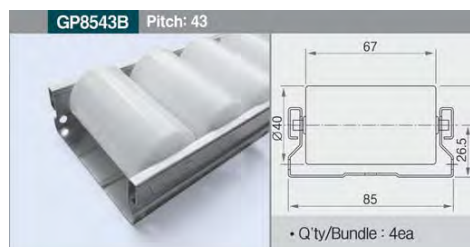
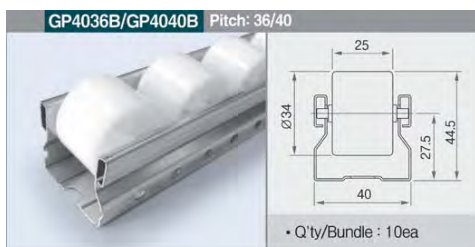
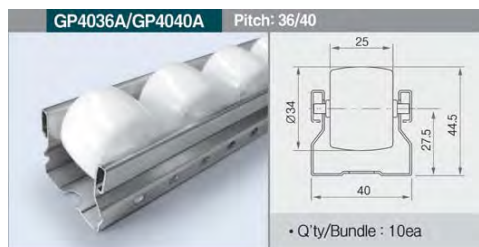
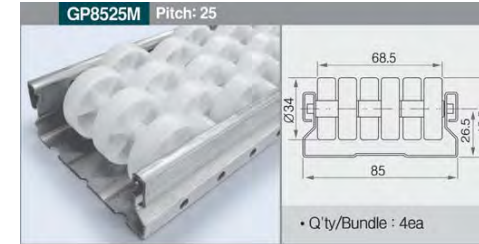
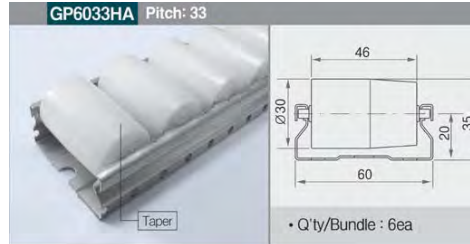
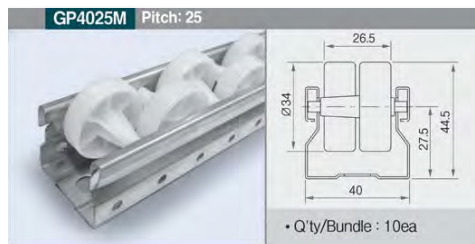
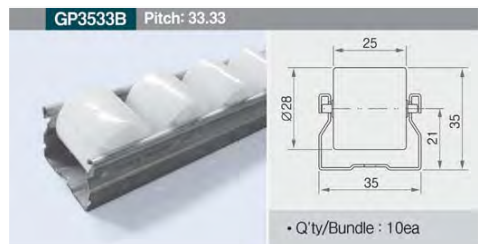
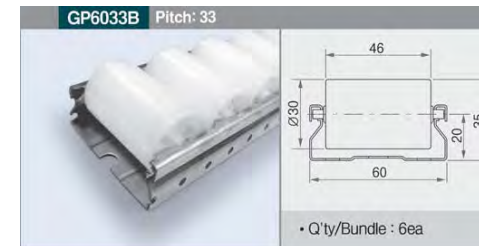
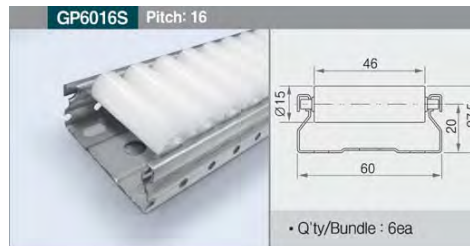
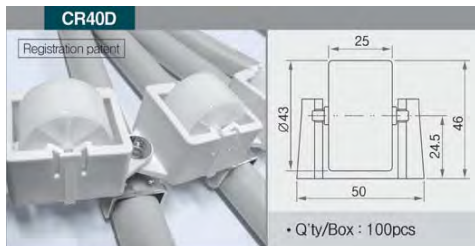
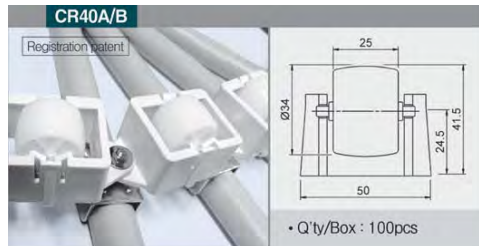

Unit : mm

Unit : mm

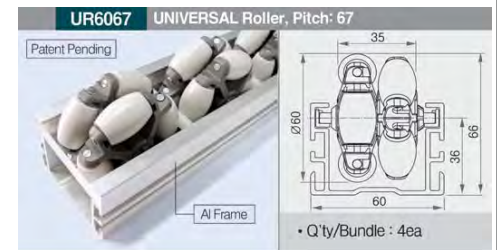
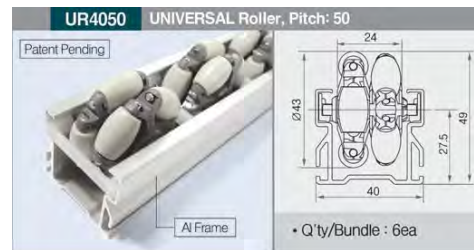
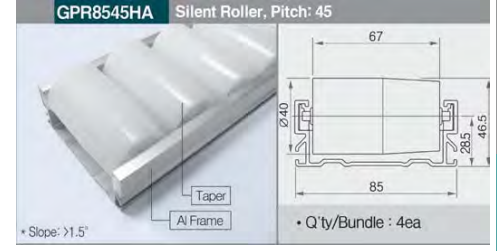
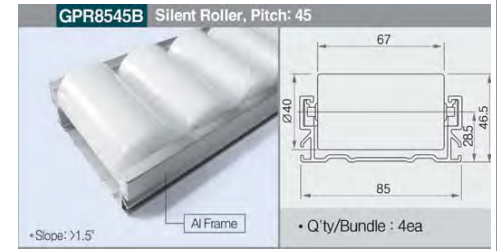
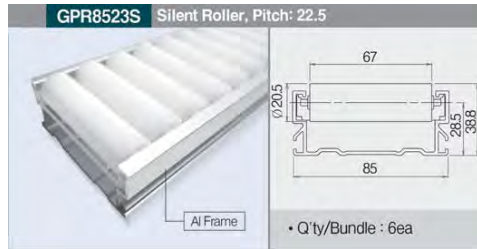
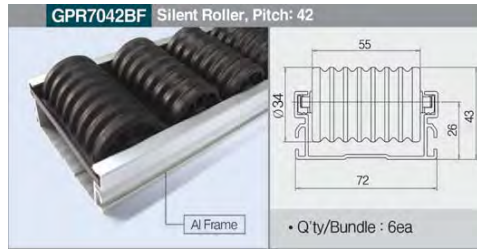
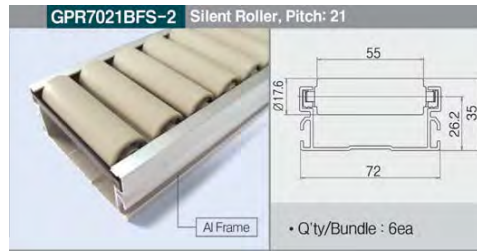
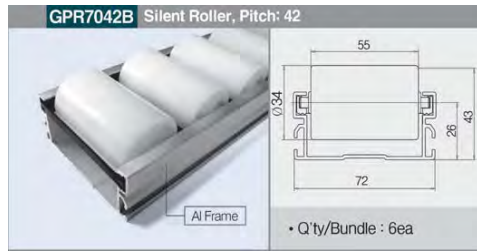
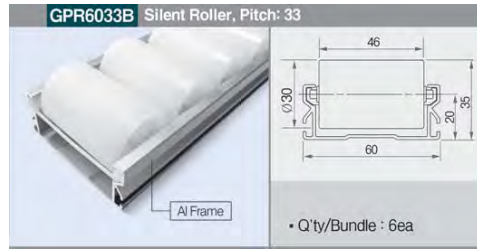
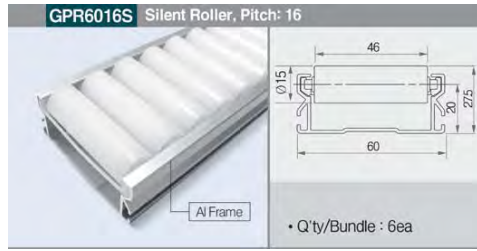

Unit : mm

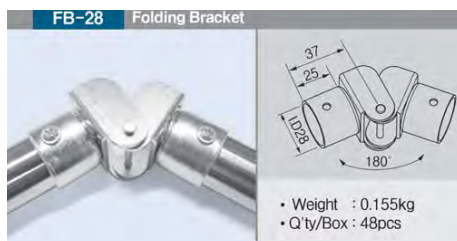
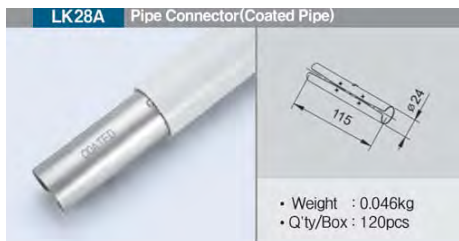
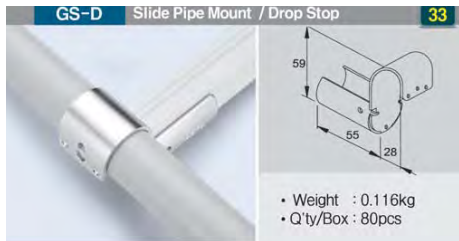
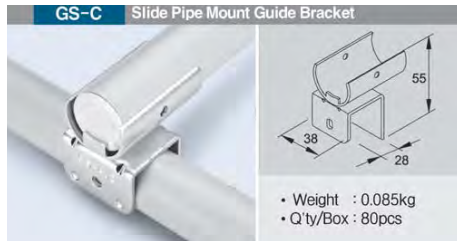
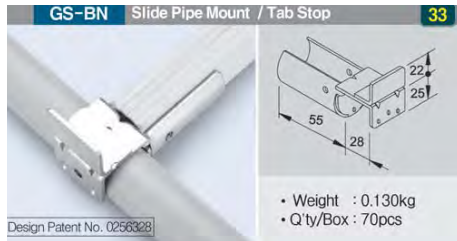
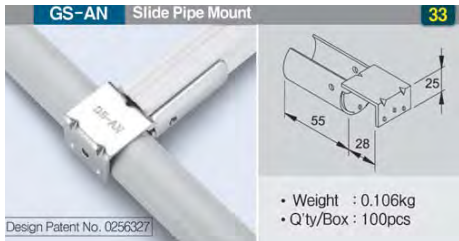

Surface Treatment - WZ

**33** is able to be fixed to the joint.  
The Part No. of 33 is GP-A33, GP-B33

Unit : mm

Unit : mm

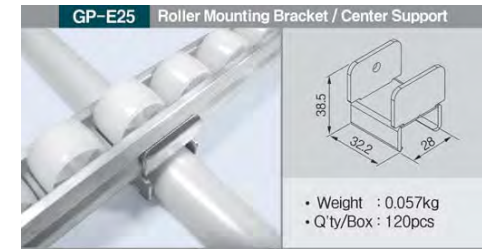
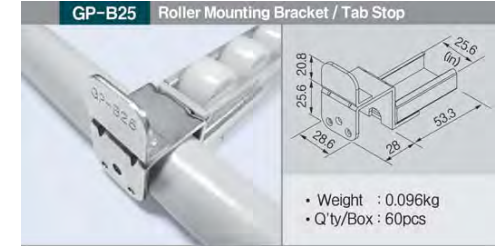
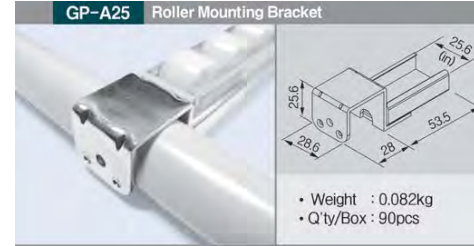

Unit : mm

**GP-A35** Roller Mounting Bracket **33**

Design Patent No. 0256325

- Weight : 0.111kg
- Q'ty/Box : 80pcs

**GP-B35** Roller Mounting Bracket / Tab Stop **33**

Design Patent No. 0256326

- Weight : 0.1326kg
- Q'ty/Box : 60pcs

**GP-B35-1** Roller Mounting Bracket / Tab Stop

- Weight : 0.240kg
- Q'ty/Box : 70pcs

**GP-C35** Roller Track Union

- Weight : 0.163kg
- Q'ty/Box : 60pcs

**GP-D35** Roller Mounting Bracket / Drop Stop

- Weight : 0.129kg
- Q'ty/Box : 70pcs

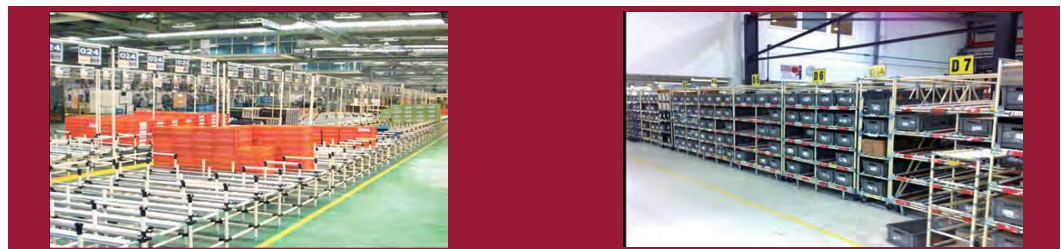

**GP-11** Adjustable Roller Union

- Weight : 0.131kg
- Q'ty/Box : 60pcs

**GP-12** Adjustable Roller Union

- Weight : 0.096kg
- Q'ty/Box : 180pcs

**GP-13** Adjustable Roller Union

- Weight : 0.173kg
- Q'ty/Box : 40pcs

**GP-14** Adjustable Roller Union

- Weight : 0.096kg
- Q'ty/Box : 180pcs

**GP-A** Roller Mounting Bracket **33**

Design Patent No. 0256325

- Weight : 0.143kg
- Q'ty/Box : 80pcs
- 33** • Q'ty/Box : 60pcs

**GP-E35** Roller Mounting Bracket

- Weight : 0.064kg
- Q'ty/Box : 120pcs

**GP-E35-A12** Roller Mounting Bracket

- Weight : 0.120kg
- Q'ty/Box : 60pcs

**GP-APF-B** Roller Mounting Bracket

- Weight : 0.160kg
- Q'ty/Box : 60pcs

**GP-APF** Roller Mounting Bracket

- Weight : 0.124kg
- Q'ty/Box : 80pcs

**GP-HN35** Roller Track Union

- Weight : 0.175kg
- Q'ty/Box : 36pcs

**GP-M35** Roller Mounting Bracket

- Weight : 0.210kg
- Q'ty/Box : 30pcs

**GP-B** Roller Mounting Bracket / Tab Stop **33**

Design Patent No. 0256326

- Weight : 0.173kg
- Q'ty/Box : 60pcs
- 33** • Q'ty/Box : 40pcs

Unit : mm

Surface Treatment - WZ

**33** is able to be fixed to the joint.  
The Part No. of 33 is GP-A33, GP-B33

Unit : mm

**GP-B-1** Roller Mounting Bracket / Tab Stop **33**

- Weight : 0.174kg
- Q'ty/Box : 50pcs
- 33 • Q'ty/Box : 40pcs

**GP-C** Roller Track Union

- Weight : 0.121kg
- Q'ty/Box : 80pcs

**GP-F** Roller Mounting Bracket **33**

- Weight : 0.175kg
- Q'ty/Box : 50pcs

**GP-FA** Adjustable Roller to Slide Pipe Union

- GS-11 & GP-13

**GP-C-1** Roller Track Union / Center Support **33**

- Weight : 0.170kg
- Q'ty/Box : 40pcs
- 33 • Q'ty/Box : 32pcs

**GP-CN** Roller Track Union

- Weight : 0.232kg
- Q'ty/Box : 36pcs

**GP-FC** Roller Mounting Bracket / Tab Stop

- Weight : 0.200kg
- Q'ty/Box : 42pcs

**GP-G** Roller Mounting Bracket / Tab Stop

- Weight : 0.250kg
- Q'ty/Box : 40pcs

**GP-DF** Roller Mounting Bracket

- Weight : 0.194kg
- Q'ty/Box : 50pcs

**GP-DN** Roller Mounting Bracket / Drop Stop **33**

- Weight : 0.165kg
- Q'ty/Box : 70pcs

**GP-HF** Roller Track Union

- Weight : 0.232kg
- Q'ty/Box : 24pcs

**GP-HN** Roller Track Union

- Weight : 0.279kg
- Q'ty/Box : 30pcs

**GP-EN** Roller Mounting Bracket / Center Support

- Weight : 0.217kg
- Q'ty/Box : 20pcs



**GP-HP** Roller Track Union

- Weight : 0.215kg
- Q'ty/Box : 24pcs

**GP-HS** Adjustable Roller to Slide Pipe Union

- Weight : 0.200kg
- Q'ty/Box : 20pcs





Unit : mm

**GP-FC60** Roller Mounting Bracket

- Weight : 0.168kg
- Q'ty/Box : 50pcs

**GP-HN60** Roller Track Union

- Weight : 0.254kg
- Q'ty/Box : 35pcs

**GP-L60** Roller Mounting Bracket

- Weight : 0.280kg
- Q'ty/Box : 30pcs

**GP-L60W** Roller Mounting Bracket

- Weight : 0.187kg
- Q'ty/Box : 30pcs

**GP-L60WB** Roller Mounting Bracket

- Weight : 0.220kg
- Q'ty/Box : 40pcs

**GP-M60** Roller Mounting Bracket

- Weight : 0.280kg
- Q'ty/Box : 30pcs

**GP-A70** Roller Mounting Bracket **33**

- Weight : 0.204kg
- Q'ty/Box : 50pcs

**GP-B70** Roller Mounting Bracket / Tab Stop **33**

- Weight : 0.280kg
- Q'ty/Box : 30pcs

**GP-E70** Roller Mounting Bracket / Center Support

- Weight : 0.170kg
- Q'ty/Box : 60pcs

**GP-EN70** Roller Mounting Bracket / Center Support

- Weight : 0.265kg
- Q'ty/Box : 12pcs

**GP-L70** Roller Mounting Bracket

- Weight : 0.209kg
- Q'ty/Box : 60pcs

**GP-M70** Roller Mounting Bracket

- Weight : 0.330kg
- Q'ty/Box : 20pcs



Example for GP-M60

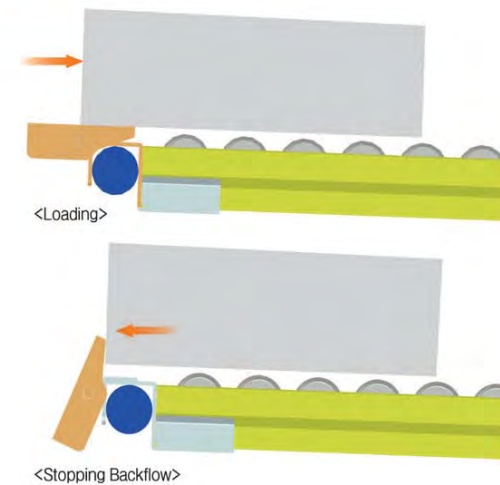

Surface Treatment - WZ

**33** is able to be fixed to the joint.  
The Part No. of 33 is GP-A33, GP-B33

Unit : mm

**GP-A85** Roller Mounting Bracket **33**

- Weight : 0.231kg
- Q'ty/Box : 40pcs

**GP-B85** Roller Mounting Bracket / Tab Stop **33**

- Weight : 0.300kg
- Q'ty/Box : 30pcs

**GP-B85-1** Roller Mounting Bracket / Tab Stop **33**

- Weight : 0.318kg
- Q'ty/Box : 20pcs

**GP-C85** Roller Track Union

- Weight : 0.140kg
- Q'ty/Box : 70pcs

**GP-C85-1** Roller Track Union / Center Support

- Weight : 0.243kg
- Q'ty/Box : 20pcs

**GP-D85** Roller Mounting Bracket / Drop Stop

- Weight : 0.235kg
- Q'ty/Box : 30pcs

**GP-E85** Roller Mounting Bracket / Center Support **33**

- Weight : 0.124kg
- Q'ty/Box : 80pcs

**GP-EN85** Roller Mounting Bracket / Center Support

- Weight : 0.324kg
- Q'ty/Box : 12pcs

**GP-L85W** Roller Mounting Bracket

- Weight : 0.276kg
- Q'ty/Box : 24pcs

**GP-M85** Roller Mounting Bracket

- Weight : 0.403kg
- Q'ty/Box : 20pcs

## BOX GUIDE PLASTIC

Unit : mm

**DP-A** Dust Plate

- Weight : 0.36kg/m

**RG-40D** Box Guide

- Weight : 0.57kg/m

**RG-40A** Box Guide

- PVC Weight : 0.50kg/m

**RG-40C** Box Guide

- PVC Weight : 0.70kg/m

**RG-40E** Box Guide

- Weight : 0.86kg/m

**SG-01** Sheet Guide

- Weight : 0.45kg/m

**SG-02** Sheet Guide

- Weight : 0.740kg/m

**SG-03** Sheet Guide

- Weight : 0.490kg/m

**SG-28A(h:30) / SG-2860A(h:60)** Box Guide

- Weight : 0.38kg/m



## BOX GUIDE ALUMINIUM

**ARG-35B** Box Guide- ELF

• Weight : 0.79kg/m

**ARG-35C** Box Guide- ELF

• Weight : 0.52kg/m

**ARG-40A** Box Guide- ELF

• Weight : 0.53kg/m

**ARG-4030BL(h:30) / ARG4045BL(h:45)** Box Guide- ELF

• Weight : 0.87kg/m

**ARG-4032AN** Box Guide- ELF

• Weight : 0.67kg/m

**ARG-40C** Box Guide- ELF

• Weight : 0.62kg/m

**ARG-40D** Box Guide- ELF

• Weight : 0.57kg/m

**ARG-40F** Box Guide- ELF

• Weight : 1.11kg/m

Unit : mm

Unit : mm

**EWS- ( ) WORK STOPPER**

**STANDARD TYPE (Material-ST5)**

**SPECIAL TYPE (Material-ST5)**

Part No	Model	Weight	Q'ty/Box
EWS-A	GP4036A/4036B	0.056kg	240pcs
EWS-B	GP4050C	0.041kg	300pcs
EWS-C	GP8550SR	0.136kg	70pcs
EWS-D	GP4050D	0.061 kg	160 pcs
EWS-E	GP3533B	0.036 kg	320 pcs
EWS-F	GP6033B	0.085 kg	170 pcs
EWS-G	GP4040A/B	0.085 kg	240 pcs
EWS-J	GP6016S	0.078 kg	200 pcs
EWS-K	GP8543B/HA	0.140 kg	90 pcs

Part No	Model	Weight	Q'ty/Box
EWS-AN	GP4036A/4036B	0.086kg	250 pcs
EWS-GN	GP4040A/B	0.056kg	250 pcs
EWS-MN	GPR8545B/HA	0.155kg	30pcs

**WR- ( ) WIRE RACKS**

Part No	Pipe	A	Weight	Q'ty/Box
WR-200		235	0.182	25
WR-300	Ø28	335	0.230	80
WR-400		435	0.271	30



**PR-01** Pipe Roller

• Weight : 0.031kg  
• Q'ty/Box : 150pcs

**SR-40** Stop Roller

• Weight : 0.012kg  
• Q'ty/Box : 450pcs



**DR-40R** Decelerating Roller

• Weight : 0.035kg  
• Q'ty/Box : 120pcs

Roller Q'ty	Maximum Box Brake Weight Per Slope	Remark
	$\theta=1.5^\circ$ $\theta=2.0^\circ$ $\theta=2.5^\circ$ $\theta=3.0^\circ$ $\theta=3.5^\circ$	
1set(2ea)	32Kg 25Kg 6 Kg 4 Kg 2.5 Kg	Roller Load = 1.4Kgf/ea
2set(4ea)	- 32Kg 12Kg 9 Kg 5 Kg	

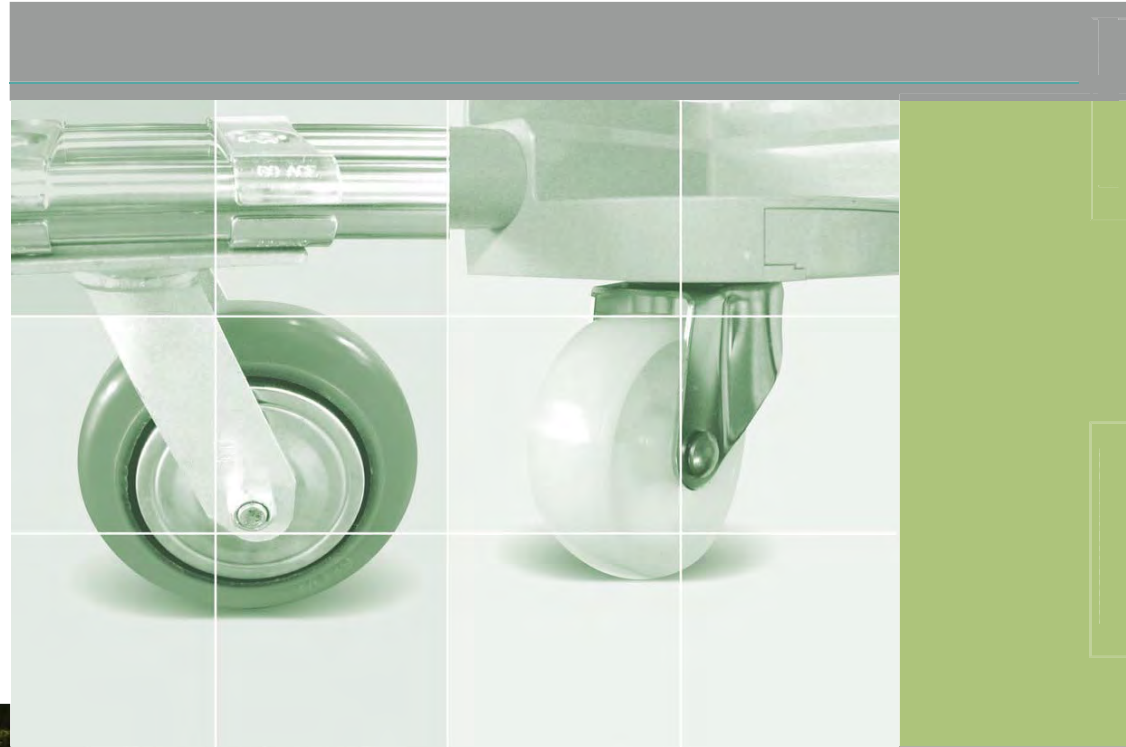

KH-200-Adjustment



KH200-6



KH200-8



	H	K	H1	L	P	S	B	Caster Height
125-140KH-200-4								
KH-200-Stainless								
KH-200-Adjustment								
KH-200-6								
KH-200-8								

