

Unit : mm

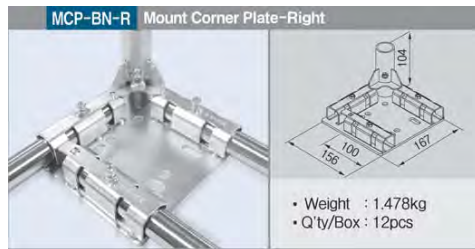
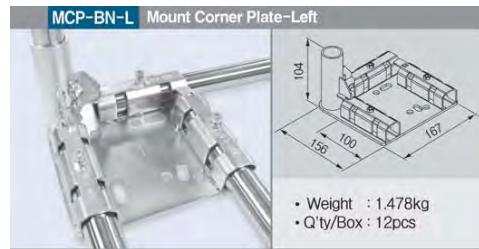
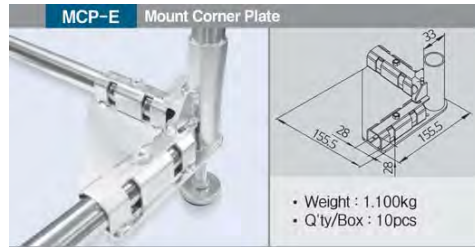
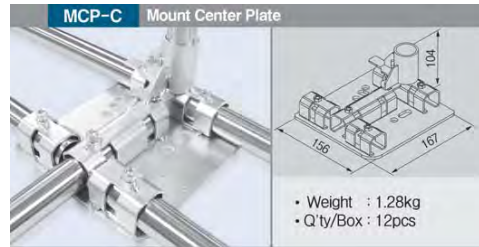
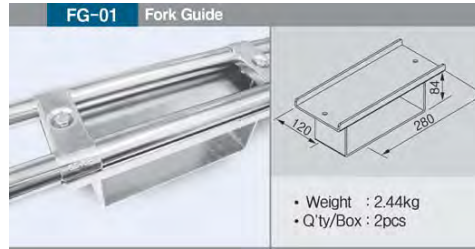
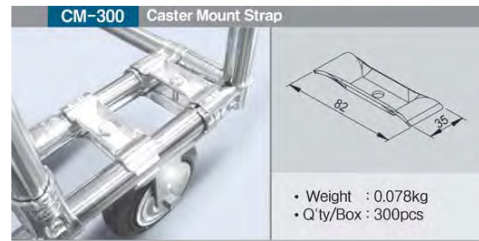
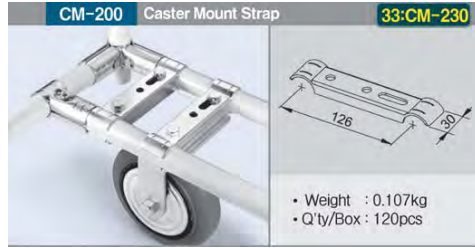
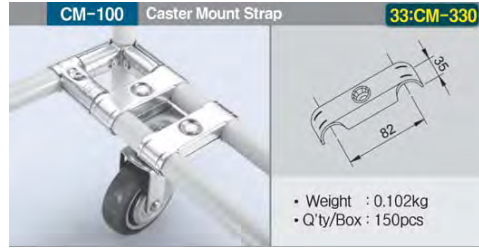

Surface Treatment - WZ

**33** is able to be fixed to the joint.  
The Part No. of 33 is GP-A33, GP-B33

## SQUARE PIPE BASE

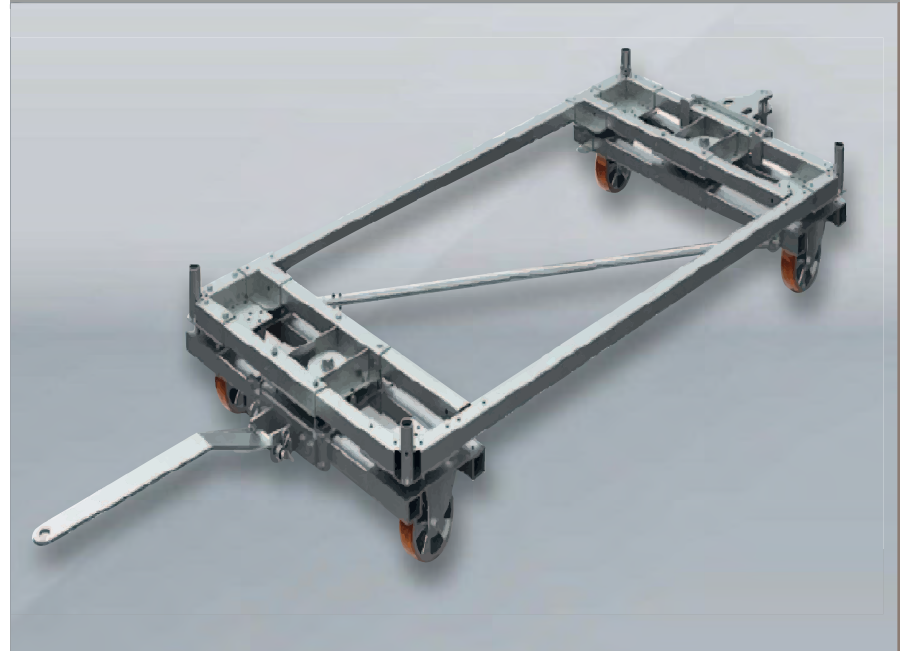

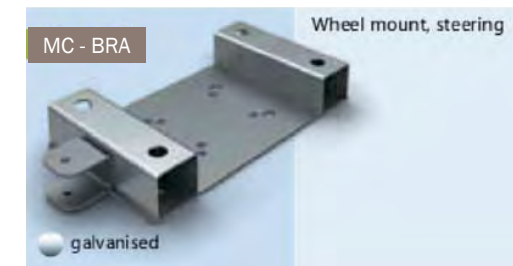
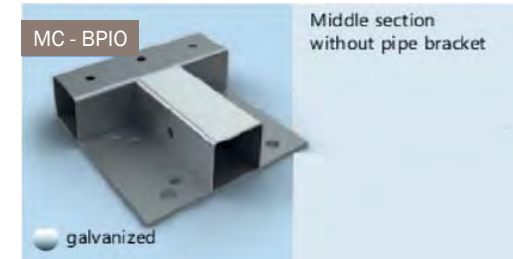
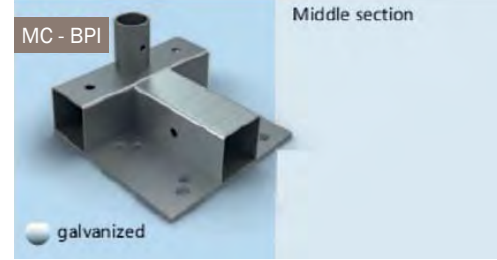
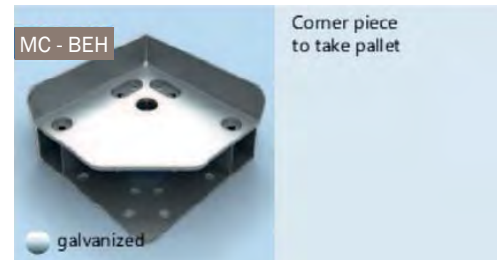
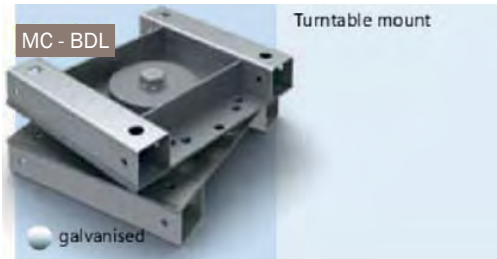
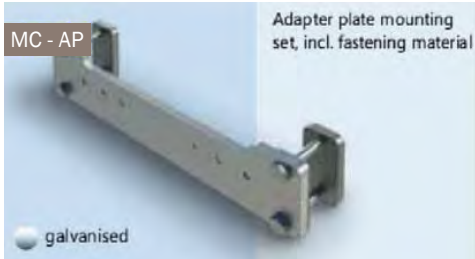

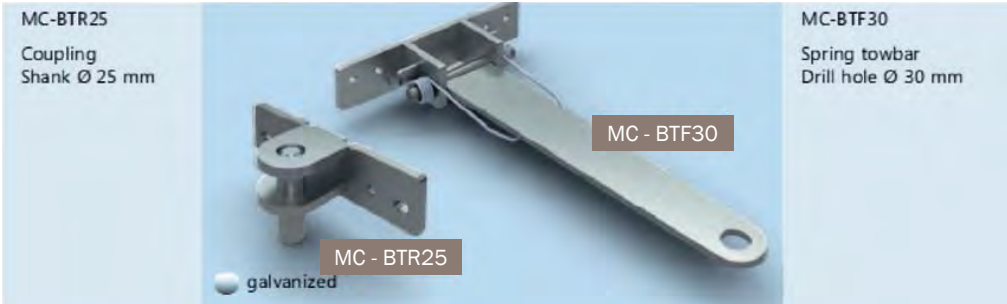

## Towing bars and couplings

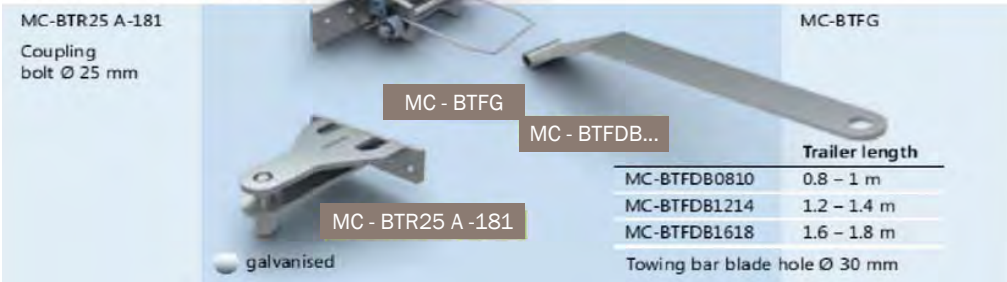

# ACCESSORIES

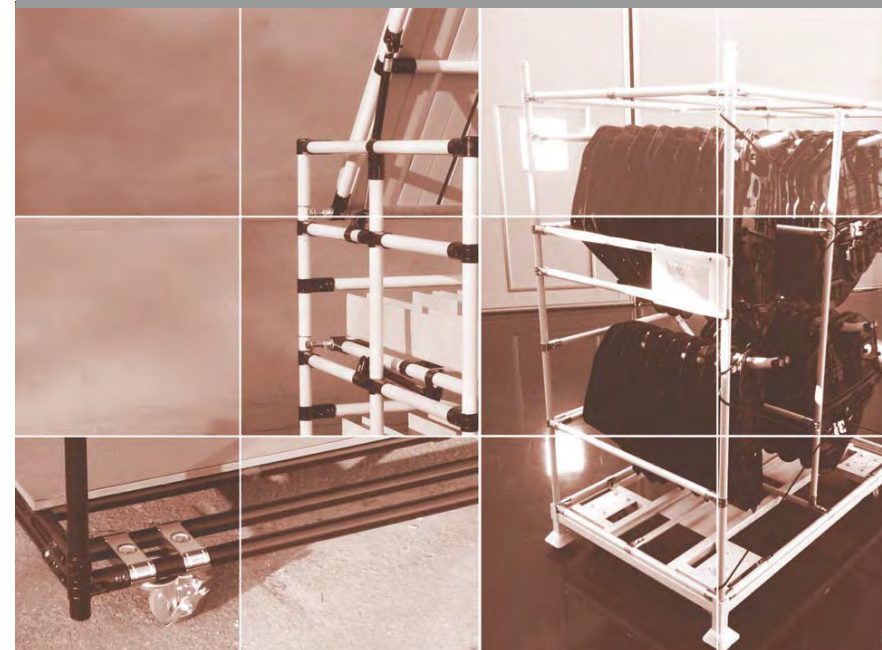

## PLASTIC COLORS

- Ivoire
- Gray
- Green
- Black (ESD)
- Dark gray

## MENU

### Plastic accessories

Accessories	76
Separators / Clamps	77

### Aluminium accessories

78 - 84

### Tiles holder

Metal holder	85
Plastic & Struts	86

### Identification

87 - 88

### Caps

pipe caps	89 - 91
safety caps	91
roller track caps	92

### Inserts

93 - 94

### Legs

95 - 96

### Screws

97

### Security

98

### Others

99 - 107